

RoboCupJunior Rescue Line Entry - Rules 2024

RoboCupJunior Rescue Line Entry Working Group		
Chair	Daniel Busse	Germany
Chair	Sören Hesterberg	Germany
	Ansgar Bredenfeld	Germany
	Joel Dierkes	Germany
	Niko Lockenvitz	Germany
	Oskar Kirmis	Germany

Official Resources

RoboCupJunior Germany Official Site	RoboCupJunior Official Forum
 <p>https://www.robocup.de</p>	 <p>https://junior.forum.robocup.org/</p>

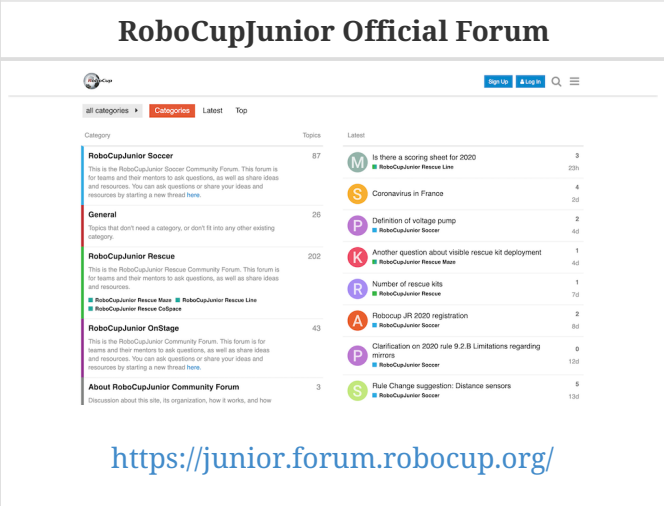

Corrections and clarifications to the rules may be posted on the Forum in advance of updating this rule file. It is the responsibility of the teams to review the forum to have a complete vision of these rules.

Before you read the rules



Please read through the [RoboCupJunior General Rules](#) before proceeding on with these rules, as they are the premise for all rules. The English rules published by the Line Entry Working Group are the only official rules for RoboCupJunior Rescue Line Entry 2024. The translated versions that can be published by each regional committee are only reference information for non-English speakers to better understand the rules. It is the responsibility of the teams to have read and understood the official rules.

Scenario

The land is simply too dangerous for humans to reach the victims. Your team has been given a difficult task. The robot must be able to carry out a rescue mission in a fully autonomous mode with no human assistance. The robot must be durable and intelligent enough to navigate through treacherous terrain with hills, uneven land and rubble without getting stuck. When the robot finally finds the victims in the evacuation zone, it has to gently and carefully transport the victims to the safe evacuation point where humans can take over the rescue. Time and technical skills are the essential! Come prepared to be the most successful rescue team.

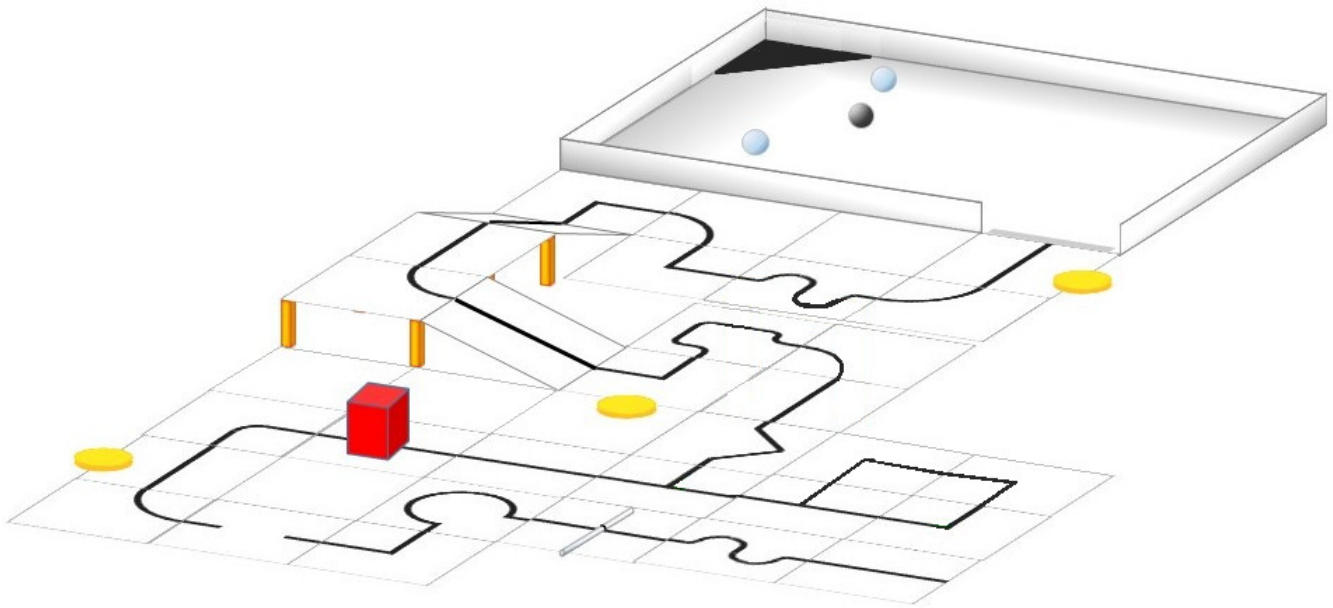

Summary

An autonomous robot should follow a black line while overcoming different problems in a modular field formed by tiles with different patterns. The floor is white in colour and the tiles are on different levels connected with ramps.

Teams are not allowed to give their robot any information in advance about the field as the robot is supposed to recognize the field by itself. The robot earns points as follows:

- 10 points for following the correct path on a tile at an intersection.
- 20 points for navigating through a seesaw tile.
- 20 points for overcoming each obstacle (bricks, blocks, weights, and other large, heavy items). A robot is expected to navigate various obstacles.
- 10 points for reacquiring the line after a tile with one or more gaps.
- 10 points for successfully navigating through a ramp (i.e., up or down successfully).
- 10 points for navigating a tile with one or more speed bumps.

If the robot gets stuck in the field, it can be restarted at the last visited checkpoint. The robot will earn points when it reaches new checkpoints. At the end of the path there will be a rectangular zone with walls (the evacuation zone). The entrance to this zone will be marked with a strip of

reflective silver tape on the floor.

Once in the evacuation zone, the robot should locate and transport the victims to the designated evacuation points. The victims are represented by spheres with an off-center center of mass of 4 to 5 cm in diameter. The live victims are reflective silver which is electrically conductive, and the dead victims are black, which is not electrically conductive. The team can earn multipliers for victim evacuations.

Contents

1. Code of Conduct	6
1.1. Spirit	6
1.2. Fair Play	6
1.3. Behavior	6
1.4. Mentors	6
1.5. Ethics and Integrity	7
1.6. Sharing	7
2. Field	7
2.1. Description	7
2.2. Floor	8
2.3. Line	8
2.4. Checkpoints	8
2.5. Speed Bumps, Debris and Obstacles	9
2.6. Intersections and Dead Ends	9
2.7. Ramps	10
2.8. Seesaws	10
2.9. Evacuation Zone	10
2.10. Victims	11
2.11. Environmental Conditions	11
3. Robots	11
3.1. Control	11
3.2. Construction	11
3.3. Team	12
3.4. Inspection	13
3.5. Violations	14
4. Play	14
4.1. Pre-game Practice	14
4.2. Humans	14
4.3. Start of Game	14
4.4. Scoring Run	15
4.5. Lack of Progress	15
4.6. Scoring	17
4.7. End of Game	19
5. Competition	19
5.1. Rounds & Scoring	19
5.2. Technical Challenge	19
5.3. SuperTeam Challenge	19
6. Open Technical Evaluation	20

6.1. Description	20
6.2. Evaluation Aspects	20
6.3. Sharing	21
7. Conflict Resolution	21
7.1. Referee and Referee Assistant	21
7.2. Rule Clarification	21
7.3. Special Circumstances	21

1. Code of Conduct

1.1. Spirit

1. It is expected that all participants (students and mentors alike) respect the aims and ideals of RoboCupJunior as set out in our mission statement.
2. The volunteers, referees and officials will act within the spirit of the event to ensure the competition is competitive, fair and, most importantly, fun.
3. **It is not whether you win or lose, but how much you learn that counts!**

1.2. Fair Play

1. Robots that cause deliberate or repeated damage to the field will be disqualified.
2. Humans that cause deliberate interference with robots or damage to the field will be disqualified.
3. It is expected that the aim of all teams is to participate fairly.

1.3. Behavior

1. Each team is responsible for verifying the latest version of the rules on the RoboCupJunior Official website prior to the competition.
2. Participants should be mindful of other people and their robots when moving around the tournament venue.
3. Participants are not allowed to enter setup areas of other leagues or other teams, unless explicitly invited to do so by team members.
4. Teams will be responsible for checking updated information (schedules, meetings, announcements, etc.) during the event. Updated information will be provided on notice boards in the venue, on the local competition website, and/or the RoboCup or RoboCupJunior websites if possible.
5. Participants and their companions who misbehave may be asked to leave the venue and risk being disqualified from the tournament.
6. These rules will be enforced equally to all participants at the discretion of the referees, officials, tournament organizers and local law enforcement authorities.
7. Teams are expected to be present at the venue early on the setup day as important activities will occur. These activities include, but are not limited to: registration, participation raffle, interviews, captains and mentor's meetings.

1.4. Mentors

1. Non-team members (mentors, teachers, parents and other family, chaperones, translators and other adult team members) are not allowed in the student work area.

2. Mentors are not permitted to be involved in building, repairing, or programming their team's robots both before and during the competition.
3. Mentor interference with robots or referee decisions will result in a warning in the first instance. If this behavior recurs, the team could face a possible elimination from the tournament.
4. Robots have to be mainly student's own work. Any robot that appears to be identical to another robot may be prompted for re-inspection.

1.5. Ethics and Integrity

1. Fraud and misconduct are not condoned. Fraudulent acts may include the following:
 - a. Mentors working on the software or hardware of student's robot(s) during the competition.
 - b. More experienced/advanced groups of students may provide advice but should not do the work for other groups. Otherwise, the team risks being disqualified.
2. RoboCupJunior reserves the right to revoke an award if fraudulent behavior can be proven after the award ceremony takes place.
3. If it is evident that a mentor intentionally violates the code of conduct, and repeatedly modifies and works on the student's robot(s) during the competition, the mentor will be banned from future participation in RoboCupJunior competitions.
4. Teams that violate the code of conduct can be disqualified from the tournament. It is also possible to disqualify a single team member from further participation in the tournament.
5. In less severe cases of violations of the code of conduct, a team will be given a warning. In severe or repeated cases of violations of the code of conduct, a team can be disqualified immediately without warning.

1.6. Sharing

1. The spirit of world RoboCup competitions is that any technological and curricular developments should be shared with other participants after the tournament. This furthers the mission of RoboCupJunior as an educational initiative.
2. Any developments may be published on the RoboCupJunior website after the event.
3. Participants are strongly encouraged to ask questions to their fellow competitors to foster a culture of curiosity and exploration in the fields of science and technology.

2. Field

2.1. Description

1. The field is made up of modular tiles, which can be used to make an endless number of different courses for the robots to traverse.
2. The field will consist of 30 cm x 30 cm tiles, with different patterns. The final selection of tiles and their arrangement will not be revealed until the day of the competition. Competition tiles

may be mounted on a hard-backing material of any thickness.

3. There will be a minimum of 8 tiles in a competition field, excluding the start and goal tile.
4. There are different tile designs (examples can be found under [Section 2.3, “Line”](#)).

2.2. Floor

1. The floor is white in colour. The floor may be either smooth or textured (like linoleum or carpet) and may have steps of up to 3 mm height in between tiles. Due to the nature of the tiles, there may be a step and/or gaps in the construction of the field.
2. Competitors should be aware that tiles may be mounted on thick backing or raised off the ground, which may make it difficult to get back on a tile where the robot comes off the course. No provision will be made to assist robots that drive off of a tile to get back onto the tile.
3. Robots must be designed so that they can navigate under tiles that form bridges over other tiles. Tiles placed above other tiles will be supported by pillars placed at tile corners with a square cross section of 25mm x 25mm, making each tile entrance/exit 25 cm. The minimum height (space between the floor and the ceiling) will be 25 cm.

2.3. Line

1. The black line, 1-2 cm wide, may be made with standard electrical insulating tape or printed onto paper or other materials. The black line forms a path on the floor. (The grid lines indicated in the drawings below are for reference only and competitors can expect tiles to be added and/or omitted.)
2. Straight sections of the black line may have gaps with at least 5 cm of straight line before each gap as measured from the shortest portion of the straight portion of the line. The length of a gap will be no more than 20 cm.
3. The arrangement of the tiles and paths may vary between rounds.
4. The line will be 10 cm away from any edge of the field, walls, pillars to support ramps, seesaws, and obstacles that do not lie ahead of the path of the robot.

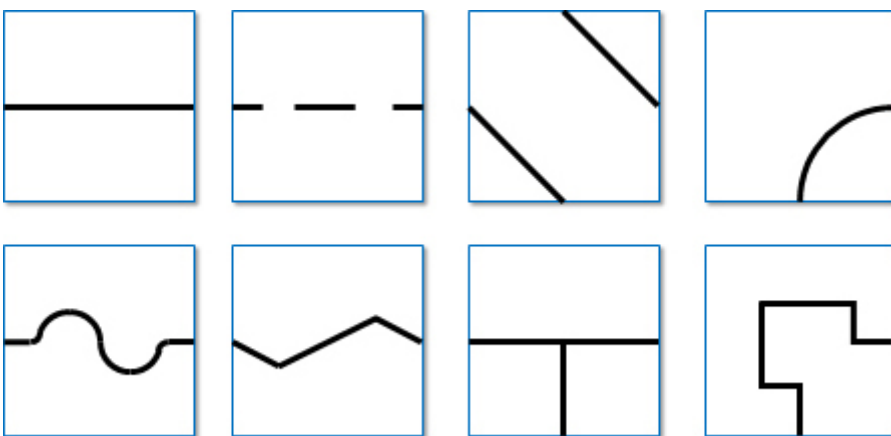

2.4. Checkpoints

1. A checkpoint is a tile which a robot will be manually placed back when a lack of progress

occurs.

2. Checkpoints will not be located on tiles with scoring elements.
3. The start tile is a checkpoint where the robot can restart.
4. A checkpoint marker is the marker that indicates for humans which tiles are checkpoints. A disk with 5 mm to 12 mm thickness and up to 70 mm in diameter has been used frequently, but can be different dependent on the organizer.
5. The number of checkpoint markers and their locations will be predetermined by the field designers.

2.5. Speed Bumps, Debris and Obstacles

1. Speed bumps will have a height of 1 cm or less and will be white. When the speed bump is placed over any black line, the overlap between the speed bump and the black line will be coloured black.
2. Debris will have a maximum height of 3 mm. It will not be fixed to the floor. Debris consists of small materials such as toothpicks or small wooden dowels, etc.
3. There will be no bumpers, debris or obstacles in the evacuation zone.
4. There will be no bumpers on tiles with elements you can score points with (e.g. gaps, intersections, ramps).
5. Obstacles may consist of bricks, blocks, weights and other large, heavy items. Obstacles will be at least 15 cm high, and can be fixed to the floor.
6. An obstacle will not occupy more than one line and/or tile.
7. There will be free space in a radius of 25 cm around each obstacle, to allow the robot to pass on both sides of the obstacle.
8. A robot is expected to navigate around obstacles. The robot may move obstacles but it should be noted that obstacles may be very heavy or fixed to the floor. Obstacles that are moved will remain where they were moved to, even if that prevents the robot from proceeding.
9. Obstacles will not be placed closer than 25 cm from the edge of the field and inclined tiles.

2.6. Intersections and Dead Ends

1. Intersections can be placed anywhere except in the evacuation zone.
2. There will be no gaps or bumpers on the tile ahead of an intersection.
3. There will be no intersection markers (see Rescue Line rules for reference). Instead the organization committee will announce the direction of the path before a round is going to start (At least 30 minutes before the first scoring run). The direction of the path (left or right) may differ from round to round.
4. There will be no dead ends.
5. The intersections are always perpendicular but may have 3 or 4 branches.

2.7. Ramps

1. Tiles will be used as ramps to allow the robots to 'climb' up and down from different levels.
2. Ramps will not exceed an incline of 25 degrees from the horizontal.
3. More than one tile may be used to build one ramp up or down. Despite the number of tiles used in the construction, the ramp will be scored as one ramp as it takes from one level to another.
4. The ramp will be scored when the robot reaches the horizontal tile at the upper level after an ascending ramp or the horizontal tile at the bottom level after a descending ramp.
5. The ramp will have a straight line with no scoring elements present.

2.8. Seesaws

1. A seesaw is comprised of a tile which can pivot around a hinge placed in the centre of a regular tile.
2. The seesaw will have an incline of less than 20 degrees when tilted to one side.
3. The seesaw tile will have a straight line with no scoring elements present.

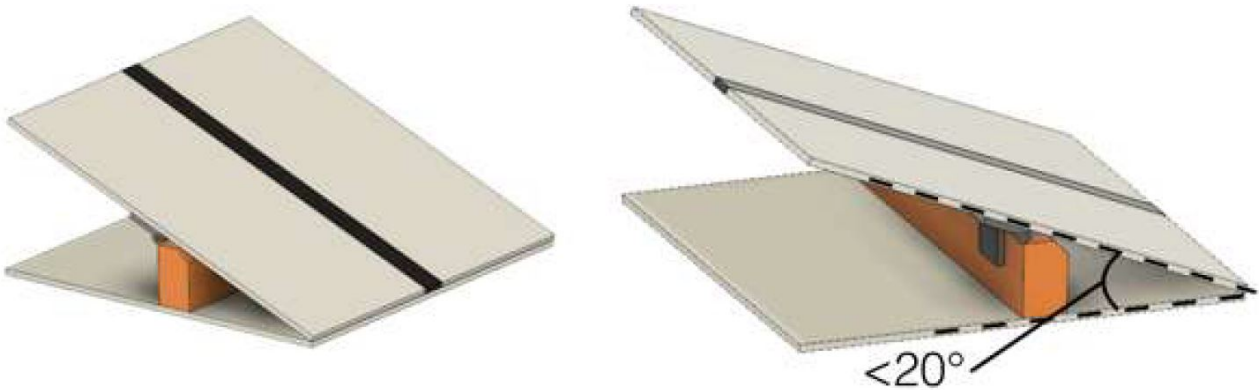

2.9. Evacuation Zone

1. The black line will end at the entrance of the evacuation zone.
2. The evacuation zone is 120 cm by 90 cm with walls around the 4 sides that are at least 10 cm high and coloured white.
3. At the entrance to the evacuation zone, there is a 25 mm x 250 mm strip of reflective silver tape on the floor.
4. The evacuation point is a black triangle with a bump of 5mm along the side that does not touch a wall.
5. The evacuation point can be placed in any of the non-entry/exit corners in the evacuation zone.
6. After a Lack of Progress, the referee may roll the dice again and place the evacuation point in a new corner.
7. The evacuation point will be fixed to the floor, but teams should be prepared for slight

movements in the evacuation point.

2.10. Victims

1. Victims may be located anywhere on the floor of the evacuation zone.
2. A victim represents a person and is in the form of a 4-5 cm diameter sphere with an off-center center of mass and a maximum weight of 80 g.
3. There are two types of victims:
 - Dead victims are black and not electrically conductive.
 - Living victims are silver, reflect light and are electrically conductive.
4. The victims will be located in a random manner in the evacuation zone. There will be exactly two live victims and one dead victim placed in the evacuation zone.

2.11. Environmental Conditions

1. The environmental conditions at a tournament may be different from the conditions at home. Teams must come prepared to adjust their robots to the conditions at the venue.
2. Lighting and magnetic conditions may vary in the rescue field.
3. The field may be affected by magnetic fields (e.g. generated by under floor wiring and metallic objects). Teams should prepare their robots to handle such interference.
4. The field may be affected by unexpected lighting interference (e.g. such as camera flash from spectators). Teams should prepare their robots to handle such interference.
5. All measurements in the rules have a tolerance of $\pm 10\%$.

3. Robots

3.1. Control

1. Robots must be controlled autonomously. The use of a remote control, manual control, or passing information (by external sensors, cables, wirelessly, etc.) to the robot is not allowed.
2. Robots must be started manually by the team captain.
3. Any pre-mapped type of dead reckoning (movements predefined based on known locations or placement of features in the field) is prohibited.
4. Robots must not damage any part of the field in any way.

3.2. Construction

1. Any robot kit or building blocks, either available on the market or built from raw hardware, may be used as long as the design and construction of the robot are primarily and substantially the original work of the students.
2. Teams are not permitted to use any commercially produced robot kits or sensors components

that are specifically designed or marketed to complete any single major task of RoboCupJunior Rescue. Robots that do not comply will face immediate disqualification from the tournament. If there is any doubt, teams should consult the RoboCupJunior Rescue Line Entry Working Group prior to the competition.

3. For the safety of participants and spectators, only lasers of class 1 and 2 are allowed. This will be checked during inspection. Teams using lasers must have the datasheet of the laser, and also must submit them prior to the competition as well as be able to show them during the competition.
4. Wireless communication is only allowed within the robot or between robots of the same SuperTeam during the SuperTeam Challenge. It is only allowed to communicate via Bluetooth class 2 or class 3 (range shorter than 20 meters) or via ZigBee. Other types of wireless communication equipment need to be removed or disabled. If the robot has other wireless communication equipment, the team must prove that this wireless communication is disabled. Any form of wireless communication from the robot to external devices is explicitly prohibited. Non-conforming robots may be immediately disqualified from the tournament. Teams are responsible for their communication. The availability of frequencies cannot be guaranteed.
5. Robots may incur damage by falling off the field, making contact with another robot, or making contact with field elements. The organizing committee cannot anticipate all potential situations where damage to the robot may occur. Teams should ensure that all active elements on a robot are properly protected with resistant materials. For example, electrical circuits must be protected from all human contact and direct contact with other robots and field elements.
6. When batteries are transported, moved or charged, it is strongly recommended that safety bags be used. Reasonable efforts should be made to ensure that robots avoid short circuits and chemical or air leaks.
7. **Robots must be equipped with a handle that is to be used to pick them up during the scoring run.**
8. **Robots must be equipped with a single binary switch or button(s) or any kind, clearly visible to the referee, specifically for restarting the robot when a lack of progress occurs. Team has to notify the referee about their LoP procedure before each scoring run, and only this procedure is allowed to be performed after a LoP.**

3.3. Team

1. Each team must have only one robot on the field.
2. Each team must comply with the [RoboCupJunior General Rules](#) regarding the number of members and each member's age.
3. The Rescue Line Entry League is open to students in the age from 10 to 14 years (age as of 1st of July).
4. Each team member will need to explain their work and should have a specific technical role.
5. A student can be registered on only one team across all RoboCupJunior leagues/sub-leagues.
6. A team is only allowed to participate in one league/sub-league in across all RoboCupJunior leagues/sub-leagues.
7. A participant may only participate twice on a Entry league level in a regional RCJ qualification

final (e.g. German Open, Portuguese Open, etc.). A participant is allowed to participate in a qualification competition for a regional final without restrictions.

8. Mentors/parents are not allowed to be with the students during the competition. The students will have to self-govern themselves (without mentor's supervision or assistance) during the long stretch of hours at the competition.

3.4. Inspection

1. The robots will be scrutinized by a panel of referees before the start of the tournament and at other times during the competition to ensure that they meet the constraints described in these rules.
2. It is illegal to use a robot that is very similar to another team's robot from a previous year or the current year.
3. It is the responsibility of the team to have their robot re-inspected, if their robot is modified at any time during the tournament.
4. Students will be asked to explain the operation of their robot in order to verify that construction and programming of the robot is their own work.
5. Students will be asked about their preparation efforts and may be requested to answer surveys and participate in video-taped interviews for research purposes.
6. All teams must complete a web form prior to the competition to allow referees to better prepare for the interviews. Instructions on how to submit the form will be provided to the teams at least 4 weeks before the competition.
7. All teams have to submit their source code prior to the competition. The source code will not be shared with other teams without the team's permission.
8. All teams must submit their engineering journal prior to the competition. The journals will not be shared with other teams without the team's permission. The organizers will request permission at the registration. A guide for the Engineering Journal format is available on the [RoboCupJunior Official website](#).



However, it is highly recommended that teams publicly share their engineering journal. With the teams that indicate that their engineering journals could be shared publicly during the registration process, the journal alongside their poster presentation will be shared through the RoboCupJunior Forum so that other teams could learn from them.

1. All teams must submit a Poster file before the competition and bring a physical Poster to the competition venue. The Poster is a public document that will be shared with the community during the Poster Presentation session at the competition venue. A template for the Poster is available on the [RoboCupJunior Official website](#).
2. The deadline for delivering the documents is scheduled for 3 weeks before the first day of the competition.

3.5. Violations

1. Any violations of the inspection rules will prevent the offending robot from competing until modifications are made and the robot passes inspection.
2. Modifications must be made within the time schedule of the tournament and teams cannot delay tournament play while making modifications.
3. If a robot fails to meet all specifications (even with modifications), it will be disqualified from that game (but not from the tournament).
4. No mentor assistance is allowed during the competition. (see [Section 1, “Code of Conduct”](#).)
5. Any violations of the rules may be penalized by disqualification from the tournament or the game or may result in a loss of points at the discretion of the referees, officials, organizing committee or general chairs.

4. Play

4.1. Pre-game Practice

1. When possible, teams will have access to practice fields for calibration and testing throughout the competition.
2. Whenever there are dedicated independent fields for competition and practice, it is at the organizers' discretion if testing is allowed on the competition fields.

4.2. Humans

1. Teams should designate one of their members as "captain" and another one as "co-captain". Only these two team members will be allowed access to the competition fields, unless otherwise directed by a referee. Only the captain will be allowed to interact with the robot during a scoring run.
2. The captain can move the robot only when they are told to do so by a referee.
3. Other team members (and any spectators) within the vicinity of the competition field have to stand at least 150 cm away from the field at all times, unless otherwise directed by a referee.
4. No one is allowed to touch the fields intentionally during a scoring run.
5. Any and all pre-mapping activities will result in immediate disqualification of the robot for the round. Pre-mapping is the act of humans providing the robot with information about the field (e.g.: location of obstacles, entrance to the evacuation zone, number of tiles after the evacuation zone, etc...) prior to the game.

4.3. Start of Game

1. Each team has a maximum of 8 minutes for a game. The game includes the time for calibration and the scoring run.
2. Calibration is defined as taking sensor readings and modifying the robot's programming to

accommodate such sensor readings. Calibration does not count as pre-mapping.

3. The scoring run is defined as the time when the robot is moving autonomously to navigate the field, and the referee will record the scores.
4. A game begins at the scheduled starting time whether or not the team is present or ready. Start times will be posted around the venue.
5. Once the game has begun, the robot is not permitted to leave the competition area.
6. Teams may calibrate their robot in as many locations as desired on the field, but the clock will continue to run. Robots are not permitted to move on their own while calibrating.
7. Once a team is ready to start a scoring run, they must notify the referee. To begin a scoring run, the robot is placed on the start tile of the course as indicated by the referee. Once a scoring run has begun, no more calibration is permitted, including changing of code/code selection.
8. Teams may choose not to calibrate the robot and instead immediately start the scoring run.
9. Once a robot begins its scoring run, the referee will roll a standard 6-sided dice to determine in which corner the evacuation point will be located.
10. Individual tiles, obstacles, and other scoring elements may be removed, added, or changed when the robot starts moving (as the scoring run begins), to prevent teams from pre-mapping the layout of the fields. This may happen on the basis of a die rolled by the referee or with another method of randomization announced by the organizers. For a particular field during a round, the referee will ensure the difficulty of the field will be kept similar and the maximum points to be constant.

4.4. Scoring Run

1. Robots will start behind the joint of the start tile and the subsequent tile along the course. Correct placement will be checked by the referee.
2. Modifying the robot during a scoring run is prohibited, which includes remounting parts that have fallen off.
3. Any parts that the robot loses intentionally or unintentionally will be left in the field until the run is over. Team members and referees are not allowed to move or remove parts from the field during a scoring run.
4. Teams are not allowed to give their robot any advance information about the field. A robot is supposed to recognize the field elements by itself.
5. The robot must follow the course completely to enter the evacuation zone.
6. The robot has reached a tile when more than half the robot is within that tile when viewed from above and the robot is actively following the line at that point in time.

4.5. Lack of Progress

1. A lack of progress occurs when:
 - a. a team captain declares a lack of progress.
 - b. a robot loses the black line without regaining it by the next tile in the sequence (see figures

at end of the section).

- c. a robot reaches a line that is not in the intended sequence.



"sequence" is not including diagonal sequence

2. If a lack of progress occurs, the robot must be positioned on the previous checkpoint tile facing the path towards the evacuation zone and checked by the referee.
3. After a lack of progress, only the LoP procedure explained to the referee before the run start is allowed to be performed (see 3.2.8).



Reset



Power OFF & ON



Change program

4. There is no limit to the number of lack of progresses within a round.
5. After three failed attempts to reach a checkpoint, a robot is allowed to proceed to the next checkpoint.
6. The team captain may choose to make further attempts at the course to earn the additional points available from scoring elements that have not already been earned before reaching the next checkpoint.
7. If a lack of progress occurs in the evacuation zone, all victims (including ones that have rolled) will remain in their current position. Victims that are held by the robot will be placed roughly on the location of the robot when the lack of progress occurred. If a lack of progress occurs as the robot exits the evacuation zone whilst carrying victims, the victims will be randomly placed in the evacuation zone.
8. Any seesaws ahead of the robot's path can be moved to the favourable direction when a lack of progress is called.

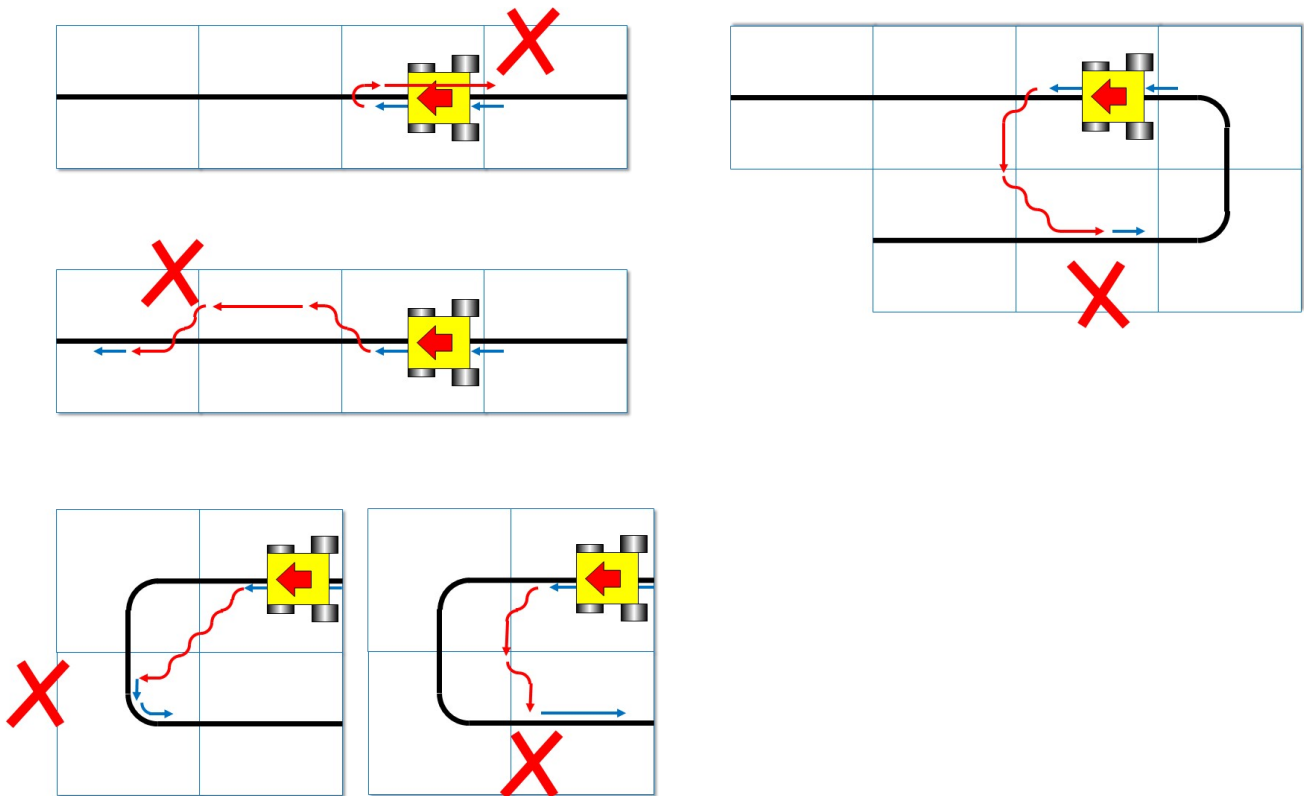

4.6. Scoring

1. A robot is awarded points for successfully navigating each hazard (gaps in the line, speed bumps, intersections, ramps, obstacles, and seesaws). Points are awarded per hazard when the robot has reached the subsequent tile in sequence. A ramp as a hazard accounts for all of the inclined tiles that make up one ramp. Point allocations are 10 points per tile with one or more gaps, 10 points per tile with one or more speed bumps, 10 points per intersection, 10 points per ramp, 20 points per obstacle, and 20 points per seesaw.
2. Failed attempts at navigating hazards in the field are defined as a Lack of Progress (see [Section 4.5, “Lack of Progress”](#)).
3. When a robot reaches a checkpoint tile, it will earn points for each tile it has passed since the previous checkpoint. The points per tile depend on how many attempts the robot has made to reach the checkpoint:
 - 1st attempt = 5 points/tile
 - 2nd attempt = 3 points/tile
 - 3rd attempt = 1 points/tile
 - Beyond the 3rd attempt = 0 points/tile

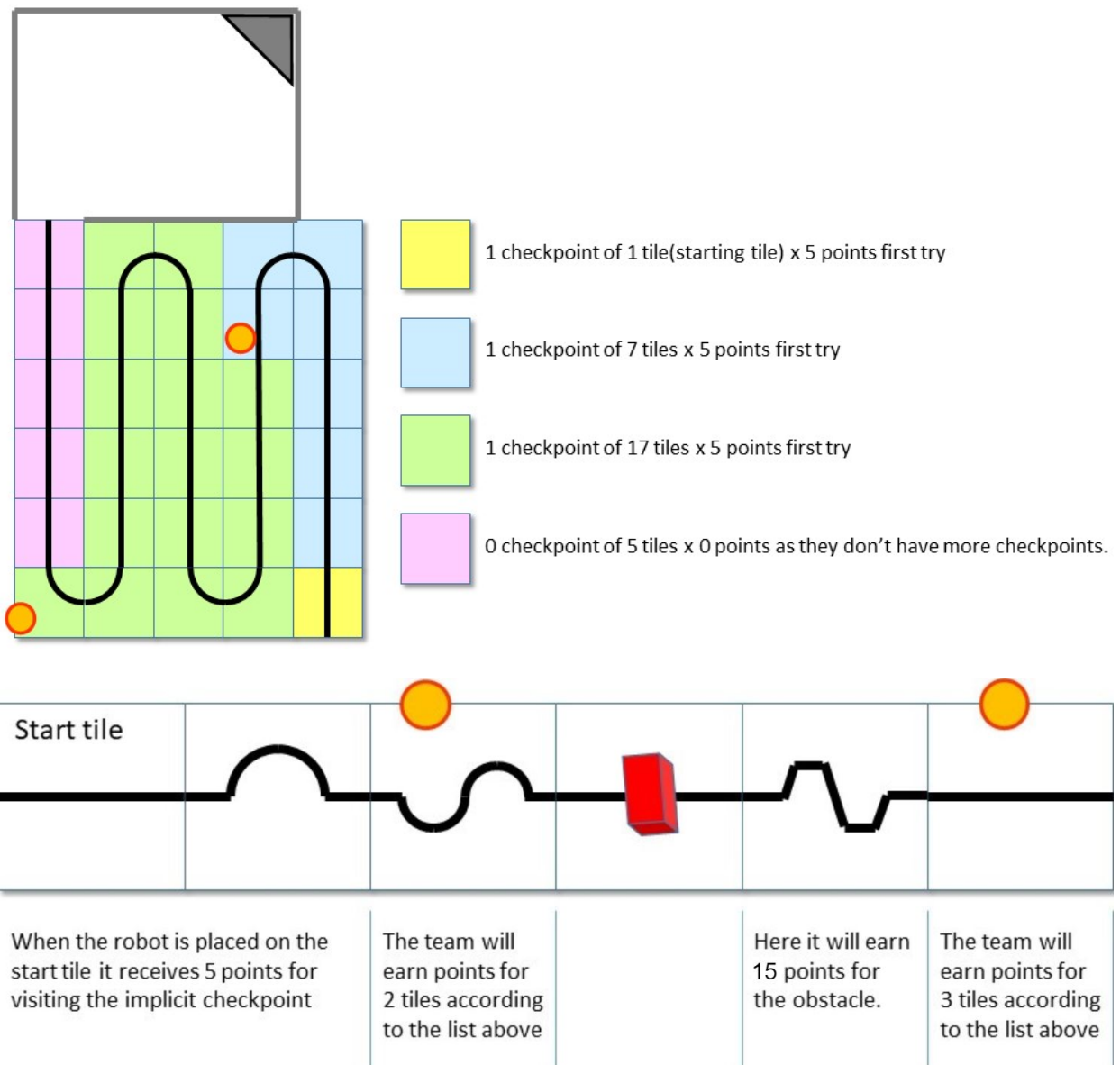

4. Each gap, speed bump, intersection, obstacle, ramp, and seesaw can only be scored once per intended direction through the course. Points are not awarded for subsequent attempts through the course.
5. Successful victim rescue: Robots are awarded multipliers for successfully rescuing victims. A successful victim rescue occurs when the victim is moved completely into the evacuation point, and no part of the robot is in contact with the victim. When the referee determines there has been a successful victim rescue, the victim will be removed from the evacuation point to allow more victims to be evacuated. The multipliers are allocated as such:
 - a. x1.4 per successful rescue of a living victim
 - b. Dead victims will result in the same multiplier as the live victim if at least one live victim has been successfully evacuated.
 - c. x1.25 if only the dead victim is evacuated
6. When a lack of progress occurs inside of the evacuation zone, 0.05 will be deducted from each of the obtained multiplier (however multipliers will not be less than 1.25).
7. Multiplier values obtained throughout the scoring run will be directly multiplied together to the sum of all the other points gained during the scoring run.

8. The multipliers obtained from evacuations are used to increase the scores obtained from the line tracing course. The scores will be rounded to the nearest integer in each round.
9. Ties in scoring will be resolved based on the time taken by each robot (or team of robots) to complete the course (this includes calibration time).

4.7. End of Game

1. A team may elect to stop the game early at any time. In this case, the team captain must indicate to the referee the team's desire to terminate the game. The team will be awarded all points earned up to the call for the end of the game. The referee will stop the time at the end of game which will be recorded as the game time.
2. The game ends when:
 - a. the 8 minutes of allowed game time expires
 - b. the team captain calls the end of the game
 - c. the robot has successfully evacuated all victims.

5. Competition

This chapter outlines the structure of an international RoboCupJunior Rescue competition. The competition format and the inclusion of elements like the SuperTeam Challenge may vary in local, regional and super-regional competitions. Please refer to the respective organiser for details.

5.1. Rounds & Scoring

1. The competition will consist of multiple rounds of which the worst one or more will be omitted from the final score.

5.2. Technical Challenge

There will be no Technical Challenge (see Rescue Line rules for reference).

5.3. SuperTeam Challenge

The SuperTeam Challenge takes place independently of the main competition and won't influence the team's individual score. It has its own award and is focussed on the cooperation between the teams.

1. Each SuperTeam will consist of at least two teams. Teams coming from regions that share a native language will not be part of the same SuperTeam.
2. The rules of the SuperTeam Challenge will be announced at the competition and require the teams of each SuperTeam to work together.
3. The SuperTeam Challenge will require substantial software changes and may require minor hardware adjustments.

6. Open Technical Evaluation

6.1. Description

1. Your technical innovation will be evaluated during a dedicated time frame. All teams need to prepare for an open display during this time frame.
2. Judges will circulate and interact with the teams. The Open Technical Evaluation is intended to be a casual conversation with a "question and answer" atmosphere.
3. The main objective of the Open Technical Evaluation is to emphasize the ingenuity of innovation. Being innovative may mean technical advances as compared to the existing knowledge, or an out-of-the-ordinary, simple but clever, solution to existing tasks.

6.2. Evaluation Aspects

1. A standardized rubric system will be used focusing on:
 - creativity
 - cleverness
 - simplicity
 - functionality
2. Your "work" can include (but is not limited to) one of the following aspects:
 - creation of your own sensor instead of a pre-built sensor
 - creation of a "sensor module" which is comprised of various electronics resulting in a self-contained module to provide a certain functionality
 - creation of a mechanical invention which is functional, but out of the ordinary
 - creation of a new software algorithm to a solution
3. Teams must provide documents that explain their work. Each invention must be supported by concise but clear documentation. The documents must show precise steps towards the creation of the invention.
4. The deadline for delivering the documents is scheduled for 3 weeks before the first day of the competition through an online form.
5. Documents must include one poster and one engineering journal (see the Engineering Journal Template on official RCJ website for more details). Teams should be prepared to explain their work.
6. Engineering Journals should demonstrate your best practices in the development process.
7. The poster should include name of team, country, league, robot description, robot capabilities, controller and programming language used, sensors included, method of construction, time used for development, cost of materials and awards won by the team in its country, etc.

6.3. Sharing

1. Teams are encouraged to review other's posters and presentations.
2. Teams awarded with certificates are required to post their documents and presentation online when asked by the OC/TC.

7. Conflict Resolution

7.1. Referee and Referee Assistant

1. All decisions during game play are made by the referee or the referee assistant, who are in charge of the field, persons and objects surrounding them.
2. During game play, the decisions made by the referee and/or the referee assistant are final.
3. At conclusion of game play, the referee will ask the captain to sign the score sheet. Captains will be given a maximum of 1 minute to review the score sheet and sign it. By signing the score sheet, the captain accepts the final score on behalf of the entire team. In case of further clarification, the team captain should write their comments on the score sheet and sign it.

7.2. Rule Clarification

1. If any rule clarification is needed, please contact the RoboCupJunior Rescue Line Entry Working Group.
2. If necessary even during a tournament, a rule clarification may be made by members of the RoboCupJunior Rescue Line Entry Working Group and Organizing Committee (OC).

7.3. Special Circumstances

1. If special circumstances, such as unforeseen problems or capabilities of a robot occur, rules may be modified by the RoboCupJunior Rescue Line Entry Working Group Chair in conjunction with available Technical Committee and Organizing Committee members, even during a tournament.
2. If any of the team captains/mentors do not show up to the team meetings to discuss problems and the resulting rule modifications described at 7.3.1, it will be understood that they agreed and were aware of the changes.